

**THE BLOCKSHOP**  
New Zealand Ltd

QUALITY MASONRY SOLUTIONS

## KERB STONE BLOCKS

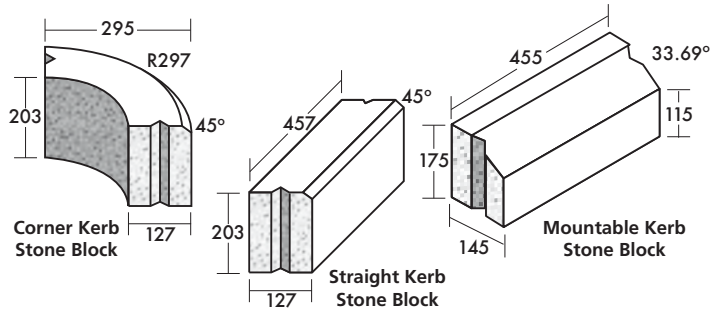

## GRASS PAVERS

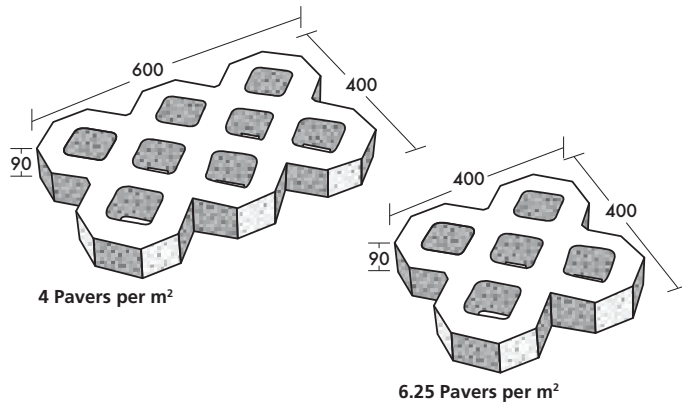

**PHONE 0800 825 625**  
**WEBSITE WWW.BLOCKSHOP.CO.NZ**

**THE BLOCKSHOP**  
New Zealand Ltd

QUALITY MASONRY SOLUTIONS

## MATERIAL ESTIMATES

1m<sup>3</sup> of Grout should fill approximately:

Product	Blocks	m <sup>2</sup>	
15 Series	200	16.0	
15 Series Bond Beam	180	14.4	72l/m
20 Series	150	12.0	
20 Series Bond Beam	120	9.6	48l/m
25 Series	100	8.0	
25 Series Bond Beam	80	6.4	32l/m

1 bag of trade mortar lays approximately 23 x 20 Series Blocks

## MASONRY BRICKS

**SIZES: 70 X 90 X 230MM**  
**70 X 115 X 230MM AND**  
**70 X 150 X 300MM**

**Yard:** 51 Firth Street, Drury

**Plant:** 148 State Highway 27, Tirau 3484

**Phone:** 0800 825 625

**Email:** info@blockshop.co.nz

**Website:** www.blockshop.co.nz

**PHONE 0800 825 625**

**WEBSITE WWW.BLOCKSHOP.CO.NZ**

**THE BLOCKSHOP**  
New Zealand Ltd

QUALITY MASONRY SOLUTIONS

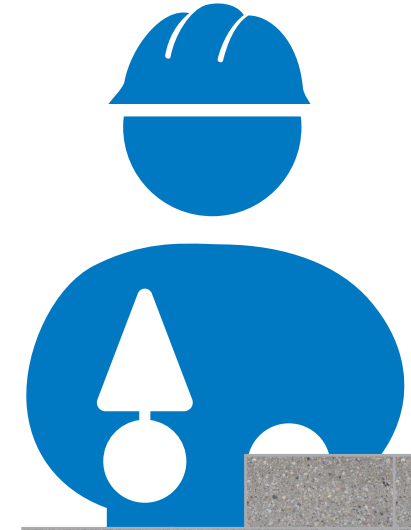

**PHONE 0800 825 625**  
**WEBSITE WWW.BLOCKSHOP.CO.NZ**

## 10 SERIES MASONRY BLOCKS

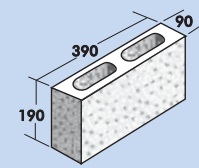

10.01  
Standard Whole

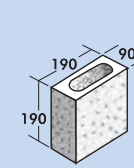

10.02  
Half

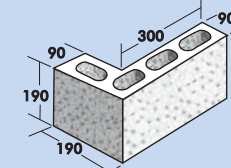

10.03  
Corner

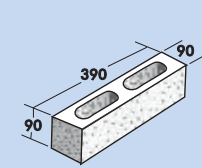

H10.01  
Standard Whole

## 15 SERIES MASONRY BLOCKS

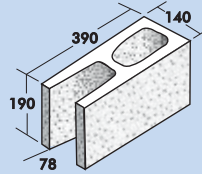

15.05  
Open End

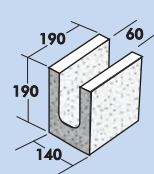

15.12  
Lintel and Half-end Closer

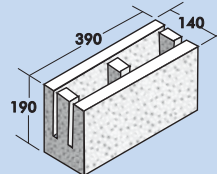

15.14  
Knock-in Bond Beam

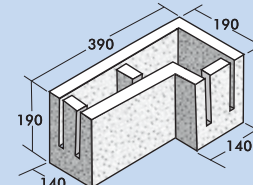

15.15  
Right Hand Corner Bond Beam  
(Left hand also available)

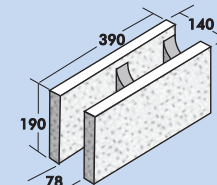

15.16  
Open End Bond Beam

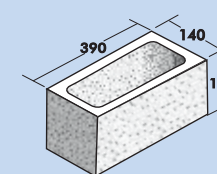

15.30  
Standard 150mm Column

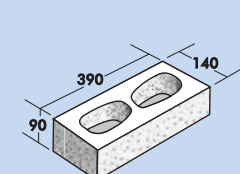

H15.04  
Half High Standard

## 20 SERIES MASONRY BLOCKS

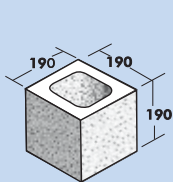

20.02  
Half

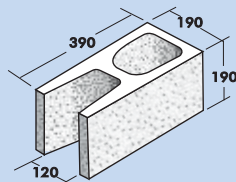

20.05  
Open End

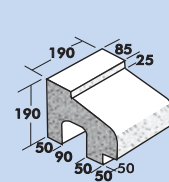

20.08  
Sill (projecting)

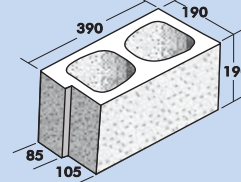

20.09  
Rebate Whole

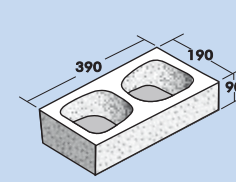

H20.04  
Standard or Corner Half High

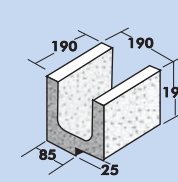

20.11  
Rebated Lintel

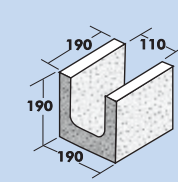

20.12  
Lintel and Half-end Closer

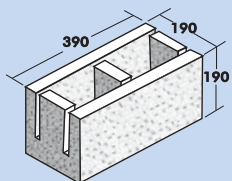

20.14  
Knock-in Bond Beam

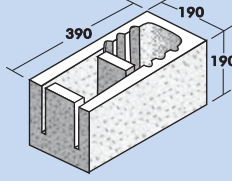

20.15  
Corner Bond Beam

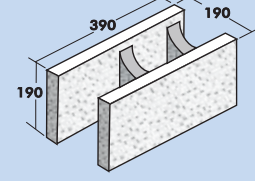

20.16  
Open End Bond Beam Depressed Web

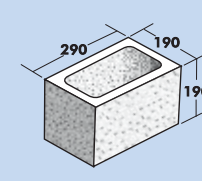

20.19  
Three Quarter

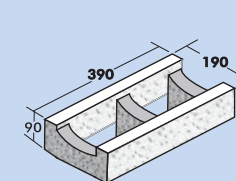

H20.14  
Bond Beam Depressed Web

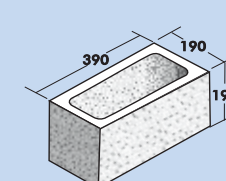

20.30  
Standard 200mm Column

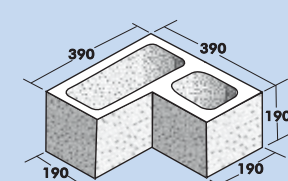

20.33  
Pier

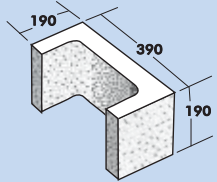

20.34  
Pilaster 'C' Type

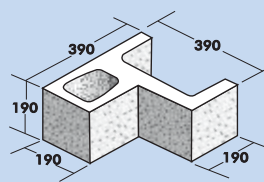

20.35  
Pilaster 'H' Type

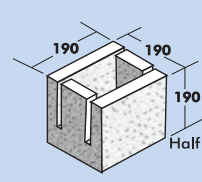

20.44  
Knock-in Half Bond Beam

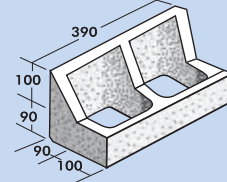

20.45  
Header

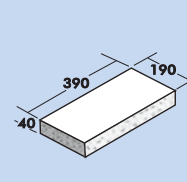

05.17  
Capping

## 25 SERIES MASONRY BLOCKS

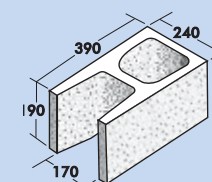

25.05  
Open End and Plain End

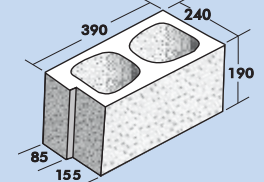

25.09  
Rebate Whole

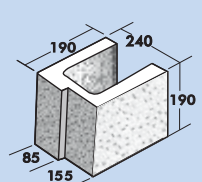

25.11  
Rebate Lintel

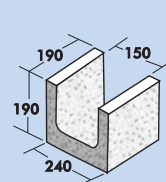

25.12  
Lintel and  
Half-end Closer

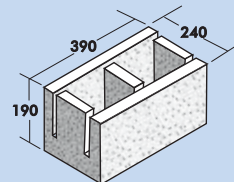

25.14  
Knock-in Bond Beam

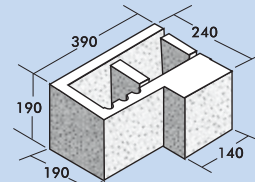

25.15  
Left Hand Corner Bond Beam  
(Right hand also available)

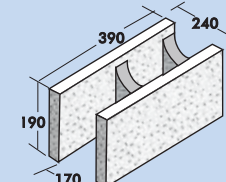

25.16  
Open End Bond Beam  
Depressed Web

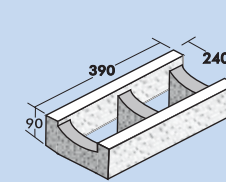

H25.14  
Bond Beam  
Depressed Web

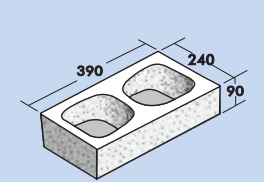

H25.04  
Standard or Corner Half High